

SERVICE MANUAL

TD 2220C

AM/FM
STEREO DIGITAL TUNER

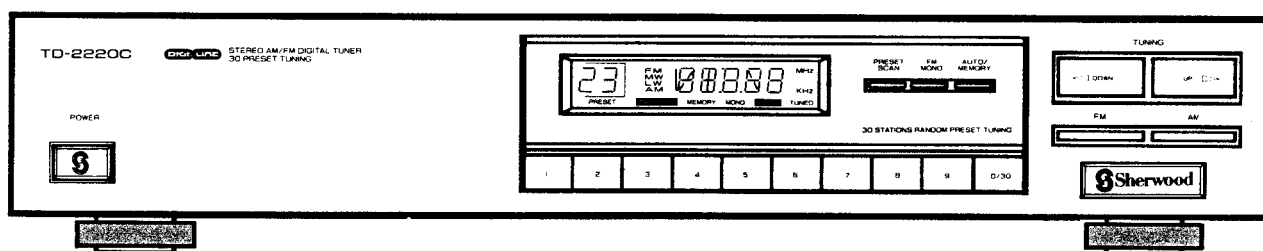

■ CONTENTS

Safety Precaution	3	Wiring Diagram	21
Specifications	4	Exploded View	23
Circuit Description	6	Electrical Parts List	25
Block Diagram	7	Mechanical Parts List	28
Alignment Procedures	9	Schematic Diagram	Separate Sheet (I)
P.C. Boards (Top & Bottom Views)	13		Separate Sheet (II)



Safety Precaution

WARNING

Service should not be attempted by anyone unfamiliar with the necessary precautions on this player. The following precautions are necessary during servicing.

1. Many electrical and mechanical parts in this player have special characteristics often pass unnoticed and the protection afforded by them cannot necessarily be obtained by using replacement components rated for higher voltage, wattage, etc. Replacement parts that have these special safety characteristic are identified in this manual and its supplements: electrical components having such features are identified by a Δ in the schematic diagram and the parts list. Before replacing any of these components, read the parts list in this manual carefully. The use of substitute replacement parts that do not have the same safety characteristics as specified in the parts list may create shock, fire or other hazards.
2. Before returning the set to the customer, always perform an AC leakage current check on the exposed metallic parts of the cabinet, such as

terminals, screwheads, metal overlays, etc. to be sure the set is safe to operate without danger of electrical shock. Plug the AC line cord directly into a 120V AC outlet (**120V Version only**). (Do not use a line isolation transformer during this check.) Use an AC voltmeter having 5000 Ω per volt or more sensitivity in the following manner:

Connect a 1500 Ω 10 watt resistor paralleled by a 0.15 μ F, 150V AC capacitor, between a known good earth ground (water pipe, conduct, etc) and the exposed metallic parts, one at a time. Measure the AC voltage across the combination of 1500 Ω resistor and 0.15 μ F capacitor. Reverse the AC plug at the AC outlet and repeat AC voltage measurements for each exposed metallic part. Voltage measured must not exceed 0.3volts RMS. This corresponds to 0.2mA AC. Any value exceeding this limit constitutes a potential shock hazard and must be corrected immediately.

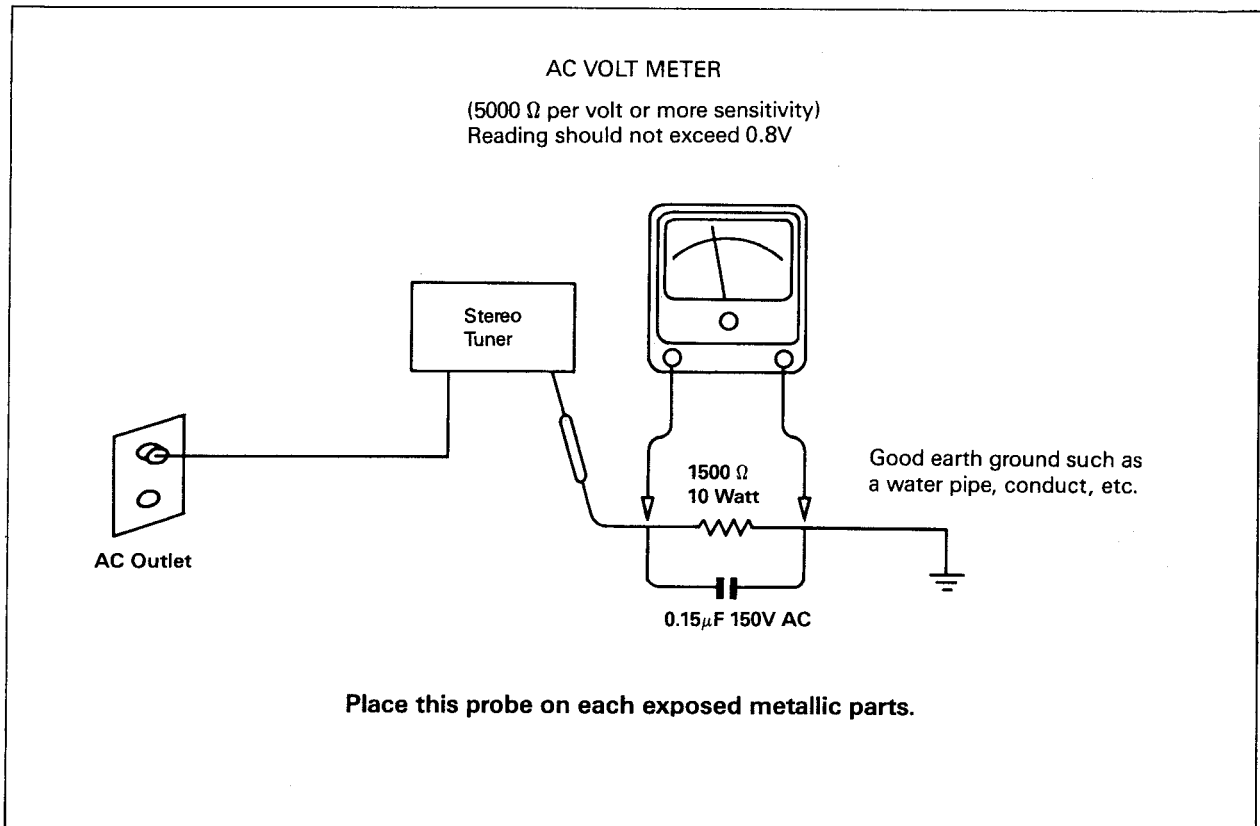

Specifications

FM Section

Tuning Range

Scanning Frequency Interval(Auto/Manual);

USA/Canada version	87.50-107.90MHz/200kHz
Europe/Australia version	87.50-108.00MHz/50kHz

Usable Sensitivity

IHF at S+N+D/N+D=30dB

75 ohm (75kHz dev.)	2 μ V (11.2dBf)
---------------------	---------------------

DIN at S+N/N=26dB

75 ohm (40kHz dev.)	1.7 μ V (9.8dBf)
---------------------	----------------------

Quieting Sensitivity at 98MHz

IHF at 75kHz dev. Mono	7 μ V (22.1dBf)
------------------------	---------------------

Stereo	70 μ V (42.1dBf)
--------	----------------------

DIN at 40kHz dev. Mono	5 μ V (19.2dBf)
------------------------	---------------------

Stereo	55 μ V (39.2dBf)
--------	----------------------

THD at 1kHz;

IHF at 75kHz mod. Mono	0.2%
------------------------	------

(40kHz for DIN) Stereo	0.4%
------------------------	------

Stereo Separation at 1kHz

	45dB
--	------

Signal to Noise ratio

IHF at 75 kHz mod. Mono	75dB
-------------------------	------

Stereo	68dB
--------	------

Frequency Response 20Hz-15kHz

	+0.5/-1dB
--	-----------

Audio Output voltage at 1kHz, 100% mod.

	600mV \pm 150mV
--	-------------------

De-emphasis;

USA/Canada version	75 μ sec
--------------------	--------------

Europe/Australia version	50 μ sec
--------------------------	--------------

Capture Ratio

	2dB
--	-----

Alternate channel selectivity

	60dB
--	------

Image Rejection

	70dB
--	------

IF Rejection

	65dB
--	------

AM Rejection

	50dB
--	------

Muting Level

	10 μ V
--	------------

AM (MW/LW) Section

Tuning Range;

MW USA/Canada version	520-1710kHz
-----------------------	-------------

Australia/Europe version	522-1611kHz
--------------------------	-------------

LW Europe version	153-279kHz
-------------------	------------

Scanning Frequency Interval (Auto/Manual)

USA/Canada version	10kHz
--------------------	-------

Australia/Europe version	9kHz
--------------------------	------

Usable Sensitivity IHF

at 20dB S/N Loop Antenna

MW	800 μ V/m
----	---------------

LW	1000 μ V/m
----	----------------

Signal to Noise ratio 30% mod. ref.

MW	45dB
----	------

LW	40dB
----	------

Audio Output voltage at 400Hz 30% mod. 150mV
 Power Consumption 12W
 Power Requirement;
 A: 120V 60Hz for USA & Canadian version
 B: 120/220V 60/50Hz for multi-voltage version
 C: 220V 50Hz for general European version
 D: 220V 50Hz for German & Italian version
 E: 240V 50Hz for British & Australian version
 F: 220V 50Hz for Swiss & Scandinavian version
 Dimensions 440(W) × 70(H) × 225(D) mm
 17.3(W) × 2.8(H) × 8.9(D) inch
 Weight(net) 3kg (6 lbs, 9.6oz)

Circuit Description

Pin Assignment

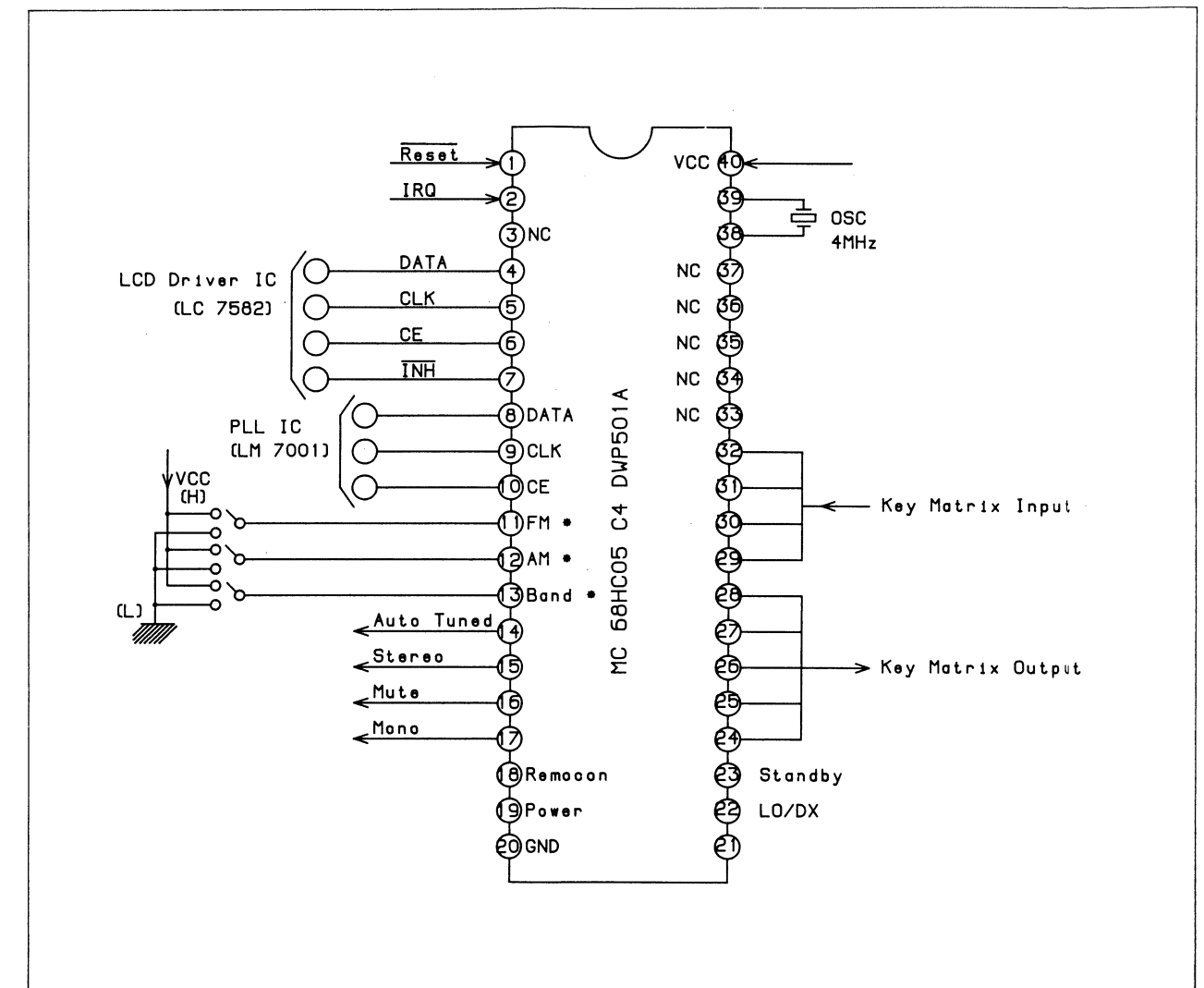

Note: Specifications and design subject to change without notice for improvements. Component and circuitry are subject to modification to insure best operation under differing local conditions. This manual is based on the American (A) standard, and provides information on regional circuit modification through use of alternate schematic diagrams, and information on regional component variations through use of parts list.

• Band & Step adj.

Pin	11	12	13
USA	H	H	L
Europe 2 (3)	L	L	L [H]
Domestic	H	L	L

Note: H: High level
 L: Low level
 11.H: 3 Band, L: 2 Band
 12.H: 10kHz, L: 9kHz
 13.H: 200kHz, L: 50kHz

Block Diagram

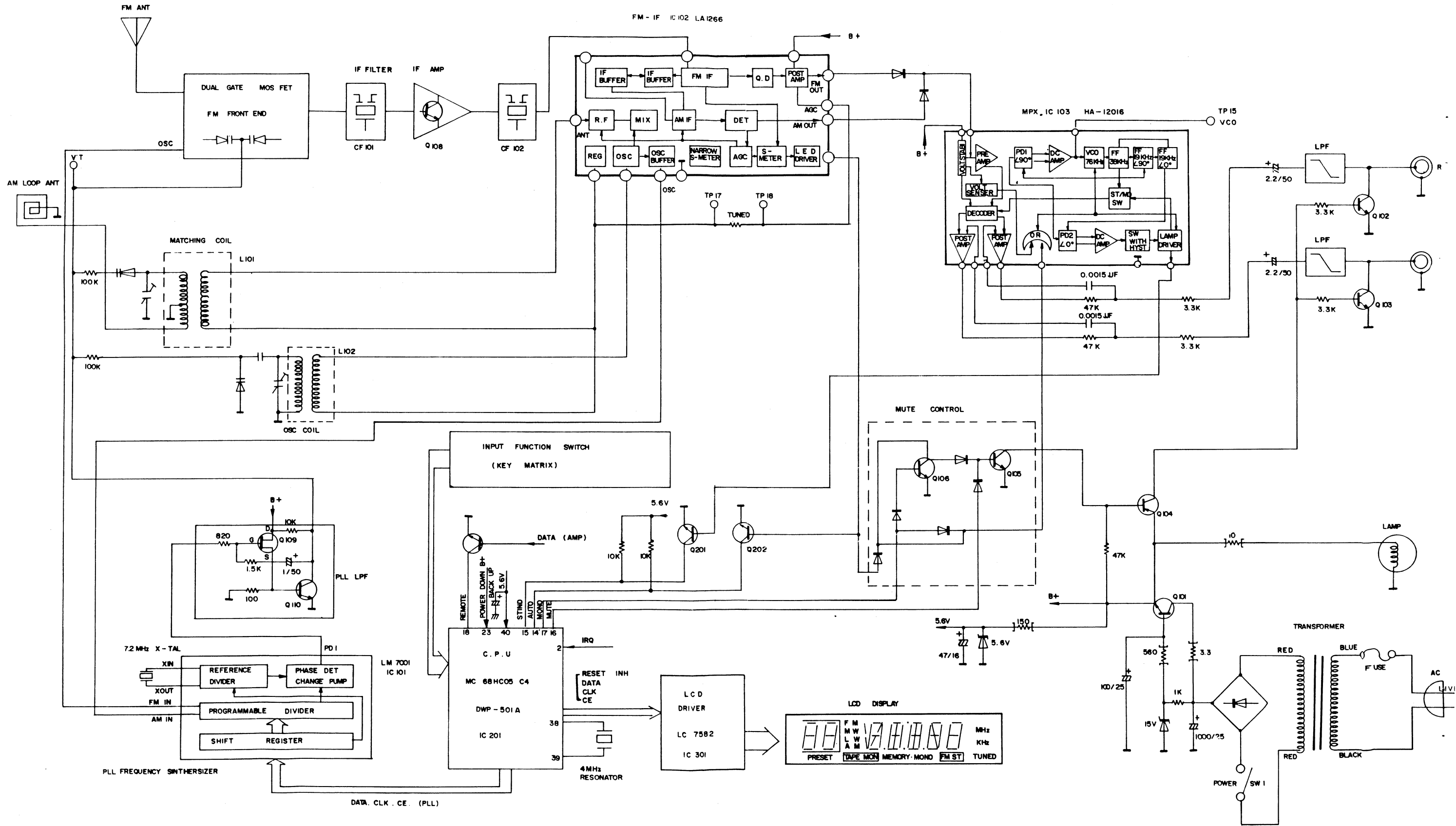

Alignment Procedures

* Before making adjustment, operate the appliance for more than 2 minutes.

- * Note: 1. 0 dB=1 μ V 2. FM 100% Mod.=75kHz Dev. 3. DVM=Digital Volt Meter
 4. SG=Signal Generator 5. SSG=Stereo Signal Generator

1. MW Adjustment

- Selector SW. _____ Tuner, MW/AM
- In case of 2 band appliance (AM/FM), MW is converted into AM.

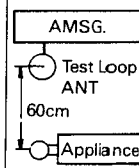
No.	Subject	Feed Signal		Setting Appliance	Measure Output	Adjust Point	Adjust For	Remark
		From	To					
1.	Tuning Voltage	520kHz		*1) 520kHz	Connect DVM to TP18	L102	DC 1.2 \pm 0.4V	
		1710kHz		*2) 1710kHz		TC102	DC 8.4 \pm 0.4V	
<ul style="list-style-type: none"> • Repeat the step *1) and *2) until DVM reads the tuning voltage mentioned above. • In case the freq. is 9kHz, the freq. of AM SG and appliance should be changed to *1) 522kHz *2) 1611kHz 								
2.	IF	AM IF Genescope	ANT.		Connect IF Genescope	L103	Symmetrical curve on AM IF Genescope	
3.	RF Tuning	*1) AM SG 600kHz, 74dB 400Hz (30% mod.)	ANT.	600kHz	Output Connect AC Voltmeter & Oscilloscope	L101	Maximize audio output	
		*2) AM SG 1400kHz, 74dB 400Hz (30% mod.)	ANT.	1400kHz		TC101		
<ul style="list-style-type: none"> • Feed Signal should be fed to Loop ant. through the TEST Loop ant., 60cm distant from the appliance • Repeat the step *1) and *2) until no further improvement occurs. • In case the freq. is 9kHz, the freq. of AM SG and appliance should be changed to *1) 603kHz and *2) 1404kHz. 								
4.	Tuned Level	AM SG 1000kHz, 80dB 400Hz (30% mod.)	ANT.	1000kHz	Output Connect Oscilloscope	VR104	TUNED Light on	in LCD
		<ul style="list-style-type: none"> • In case the freq. step is 9kHz, the freq. of AM SG and appliance should be changed to 999kHz. 						

2. LW Adjustment

- Selector SW. _____ Tuner, AM
- This adjustment is necessary to 3 band (MW/LW/FM).

No.	Subject	Feed Signal		Setting Appliance	Measure Output	Adjust Point	Adjust For	Remark
		From	To					
1.	Tuning Voltage	153kHz	279kHz	*1) 153kHz	Connect DVM to TP18	LL102	DC 2 \pm 0.2V	
				*2) 279kHz		LTC102	DC 5.5 \pm 0.2V	
<ul style="list-style-type: none"> • Repeat the step *1) and *2) until DVM reads the tuning voltage mentioned above. 								

No.	Subject	Feed Signal		Setting Appliance	Measure Output	Adjust Point	Adjust For	Remark
		From	To					
2.	RF Tuning	*1) AM SG 162kHz, 80dB 400Hz (30% mod.)	ANT.	162kHz	Output Connect AC Voltmeter & Oscilloscope	LL101	Maximize audio output	
		*2) AM SG 252kHz, 80dB 400Hz (30% mod.)		252kHz		LTC101		
<ul style="list-style-type: none"> • Feed Signal should be fed to Loop ant. through the Test Loop ant., 60cm distant from the appliance • Repeat the step *1) and *2) until no further improvement occurs. 								

3. FM Adjustment

- Selector SW. _____ TUNER, FM (Mono/Stereo)
- Deviation _____ USA/Canada (75 kHz Dev.)
Europe (40 kHz Dev.)

No.	Subject	Feed Signal		Setting Appliance	Measure Output	Adjust Point	Adjust For	Remark
		From	To					
1.	Tuning Voltage			87.50 MHz 107.90 MHz	Connect DVM	TP18	DC $2.0 \pm 0.2V$ DC $8.8 \pm 0.2V$	
2.	IF	FM IF Genescope	ANT.	98.10MHz 60dB	TP16 & TP17 Connect IF Genescope	L105	Symmetrical S curve on FM IF Genescope	
					TP16 & TP17 Connect DVM		DC $0 \pm 50mV$	
				Detune	Connect Oscilloscope	L105	Maximize noise output	In case IF Genescope is not available
					TP16 and TP17 Connect DVM		DC $0 \pm 50mV$	
3.	THD (Mono)	FM SG 98.10MHz, 60dB 1kHz (75kHz dev.)	ANT.	98.10MHz Mono	*1) Output Connect DVM	L105	DC $0 \pm 0.05V$	TP 16 and TP17
					*2) Output Connect AC Voltmeter & Distortion Analyzer		L104	
<ul style="list-style-type: none"> • Adjust the step *1) 1st and the step *2) next and repeat until no further improvement occurs. 								
4.	MPX (VCO)	FM SSG 98.10MHz, 60dB 1kHz (75kHz dev.) Pilot 19kHz (9% mod.)	ANT.	98.10MHz Stereo	TP15 Connect freq. Counter	VR102	Read 76kHz	
<ul style="list-style-type: none"> • Before adjustment, set the FM SSG to 'Mod. Off'. 								

No.	Subject	Feed Signal		Setting Appliance	Measure Output	Adjust Point	Adjust For	Remark
		From	To					
5.	THD (Stereo)	FM SSG 98.10MHz, 60dB 1kHz (75kHz dev.) Pilot 19kHz (9% Mod.)	ANT.	98.10MHz Stereo	Output connect AC voltmeter & distortion	Front- End	Minimize distortion	
6.	Mute Level	FM SG 98.0 MHz, 10 μ V (5 μ V for Europe) 1kHz (75kHz Dev.) (40kHz dev. for Europe)	ANT	98.10MHz Stereo	Output connect Oscilloscope	VR103	Muting occurs marginally	
7.	Separa- tion	*1) FM SSG 98.10MHz, 60dB 1kHz (75kHz, dev) Pilot 19kHz (9% mod) (Lch->Rch)	ANT	98.10MHz Stereo	R ch Mod connect AC voltmeter & distortion analyzer and oscilloscope	VR101	Minimize output	L ch Mode
		*2) Same as above (Rch->Lch			L ch Mod connect same as above		Minimize output	R ch Mode
		• Repeat the step *1)until no further improvement occurs.						

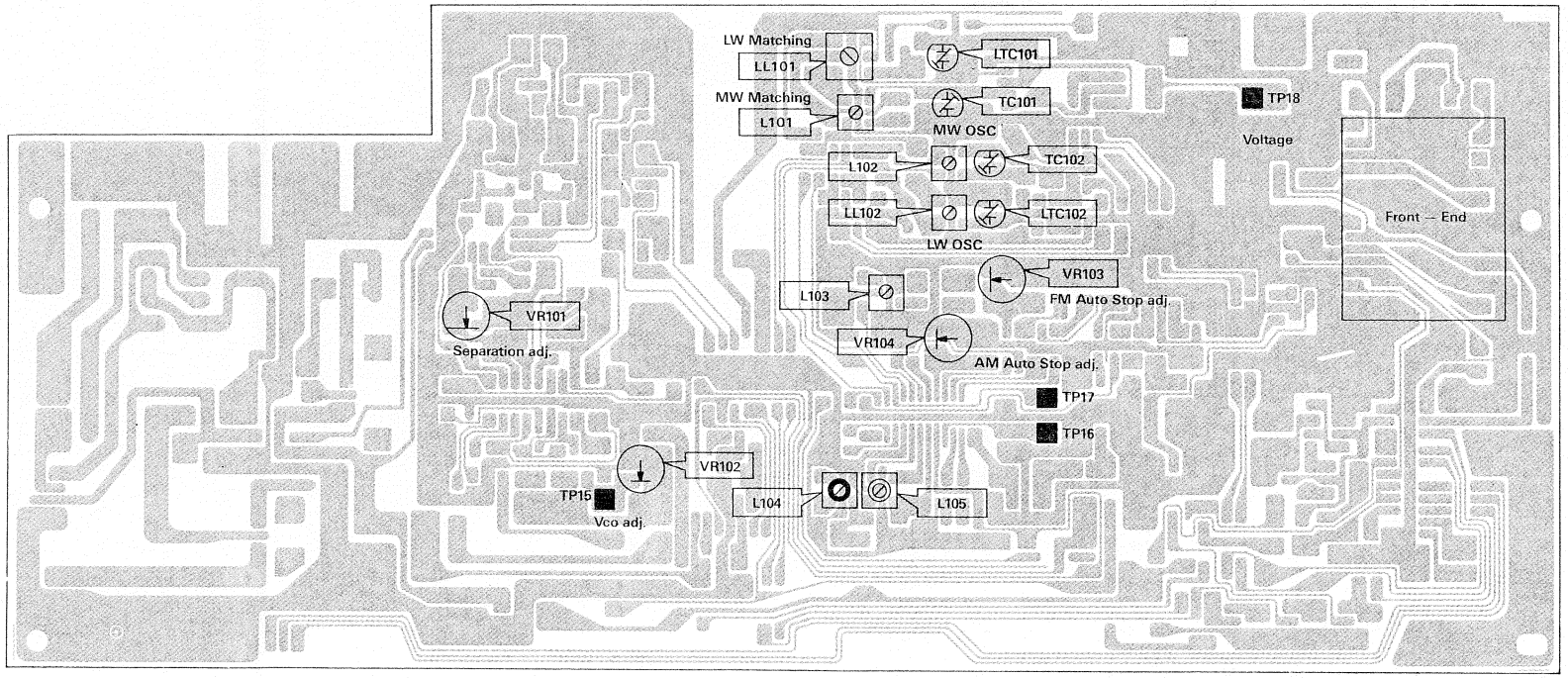

PC Boards (Top & Bottom Views)

MAIN BOARD 4002216100

(TOP VIEW)

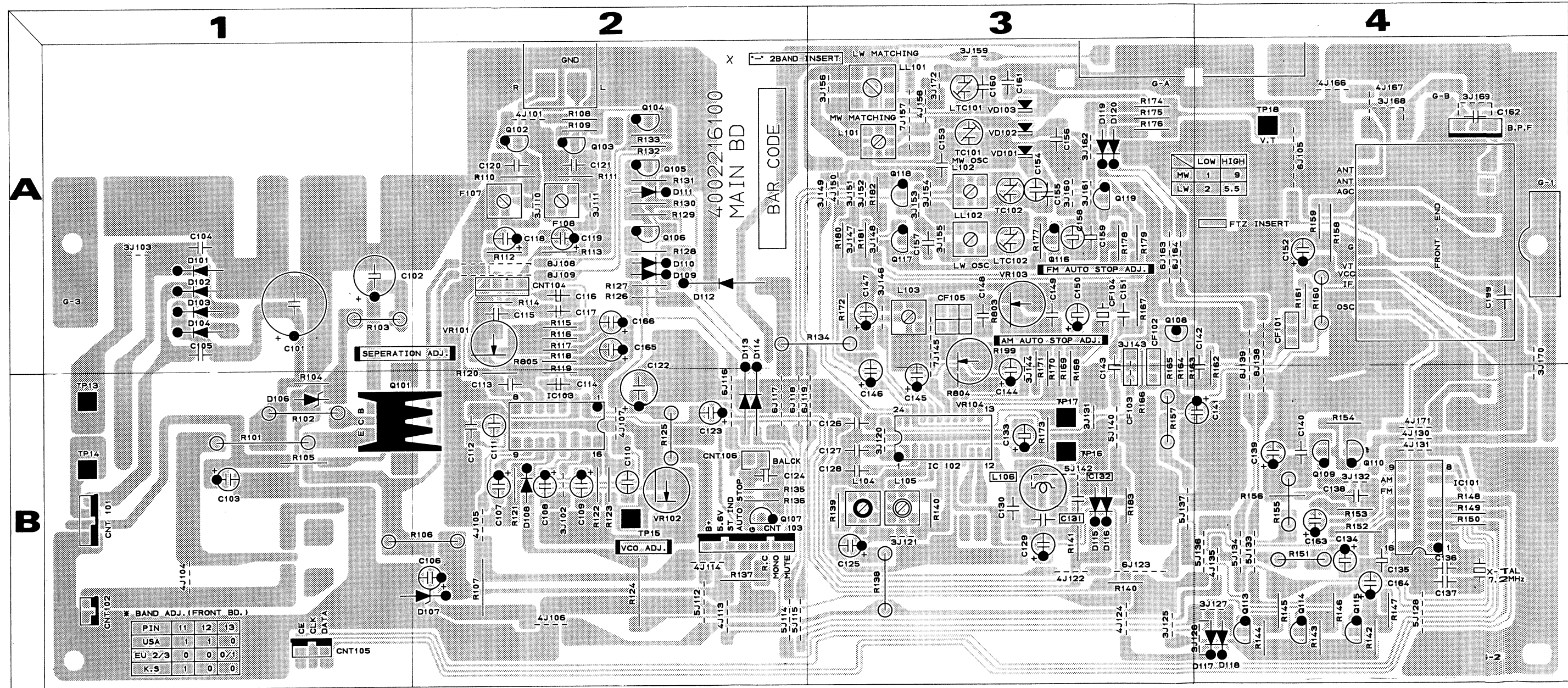

(BOTTOM VIEW)

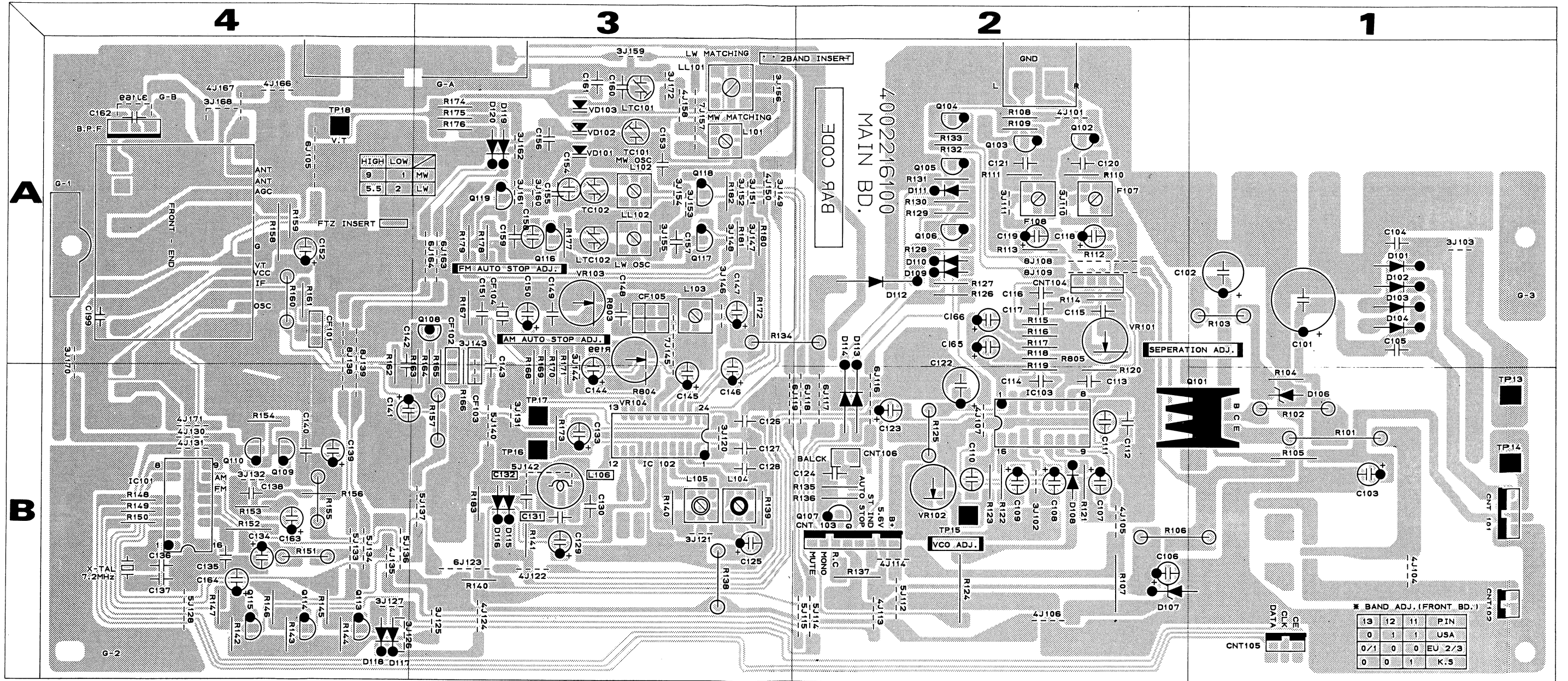

FRONT BOARD 4002216110
(TOP VIEW)

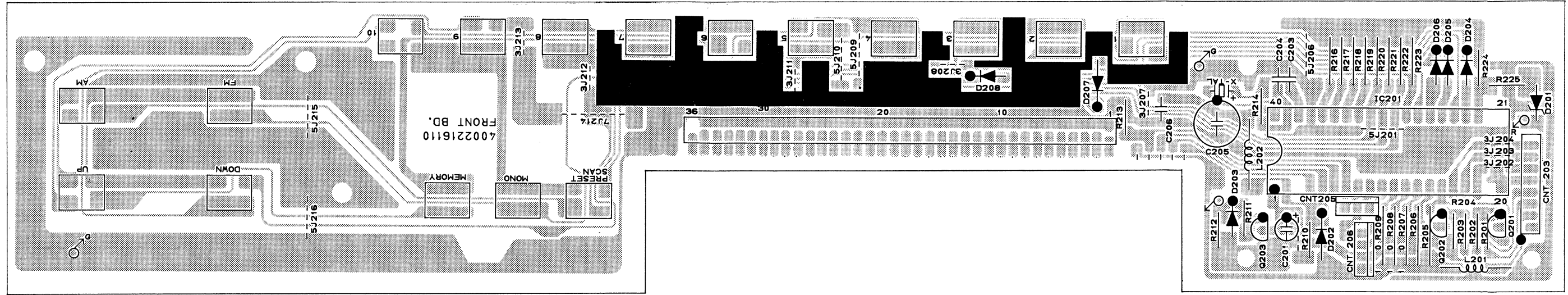

(BOTTOM VIEW)

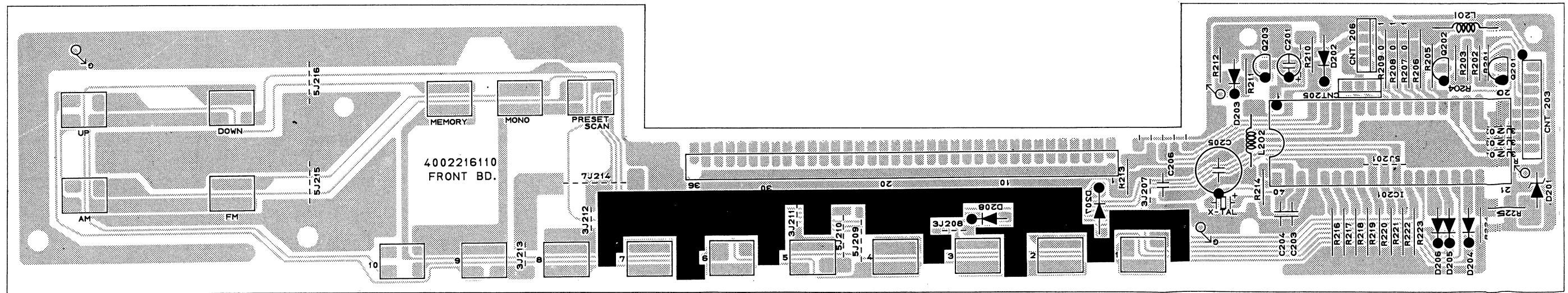

LCD BOARD 4002216140

(TOP VIEW)

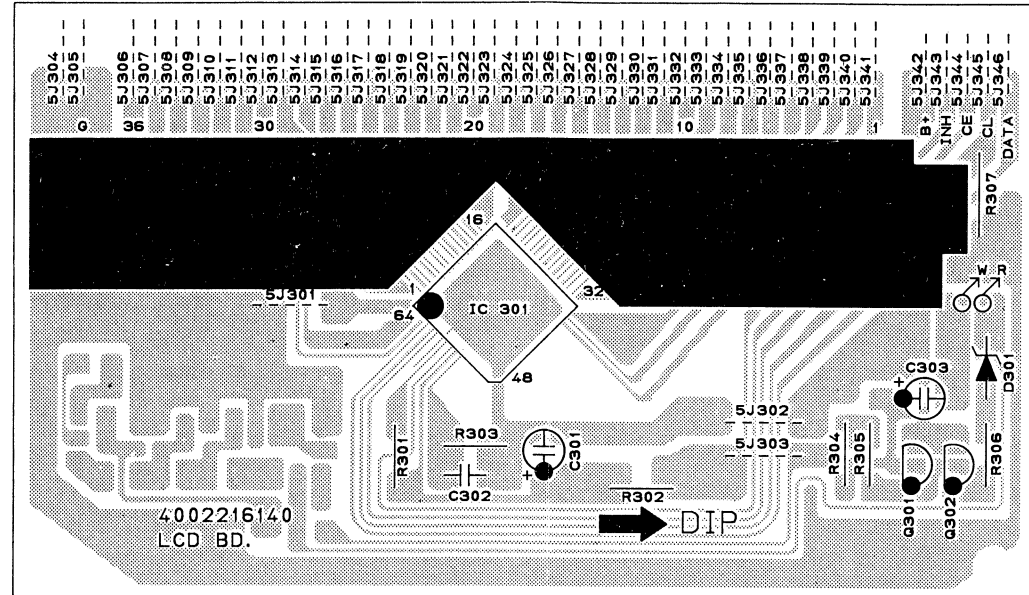

(BOTTOM VIEW)

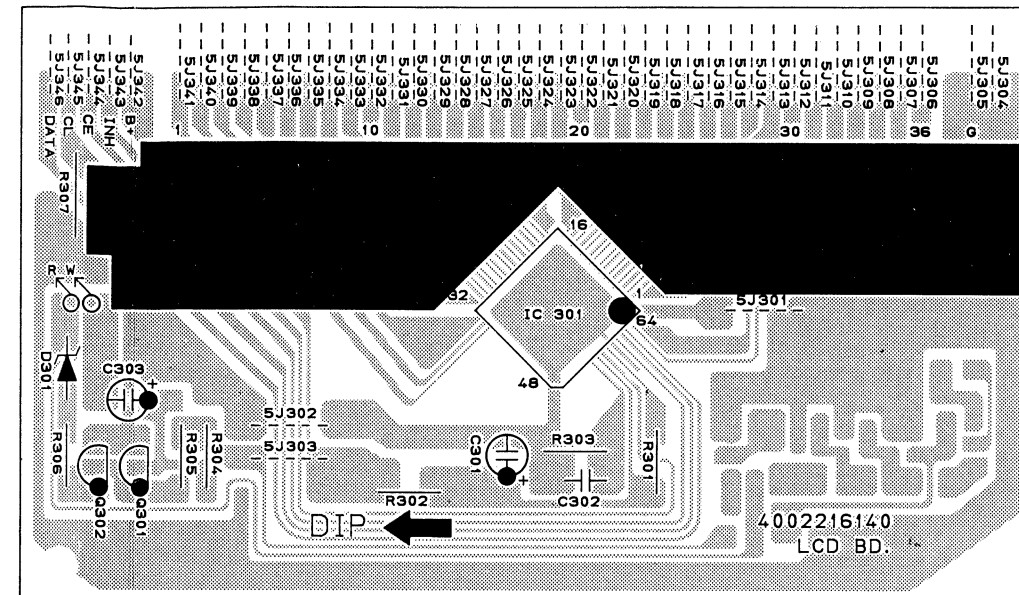

FUSE BOARD 4002216120

(TOP VIEW)

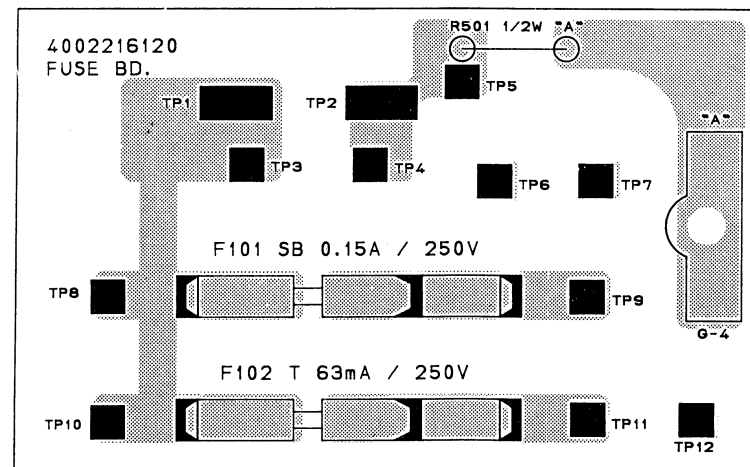

(BOTTOM VIEW)

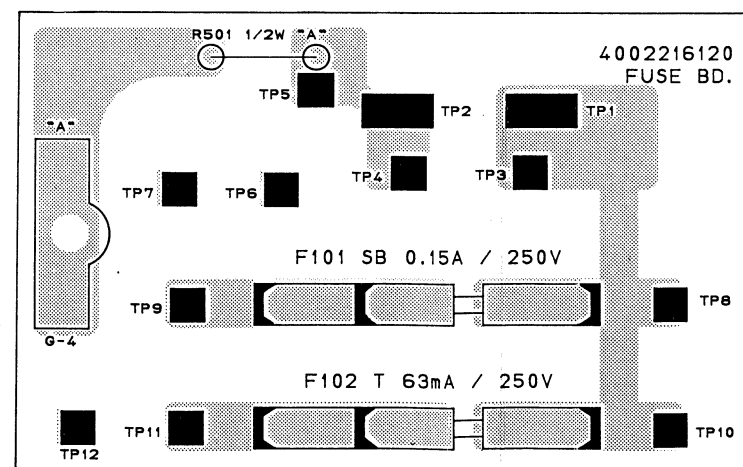

DE-EMPHASIS BOARD ('B' Version only) 4002216150

(TOP VIEW)

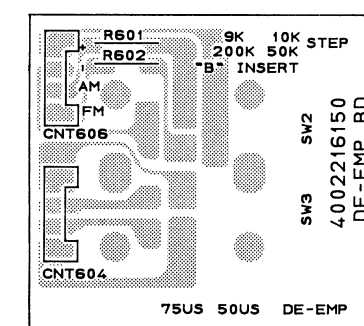

(BOTTOM VIEW)

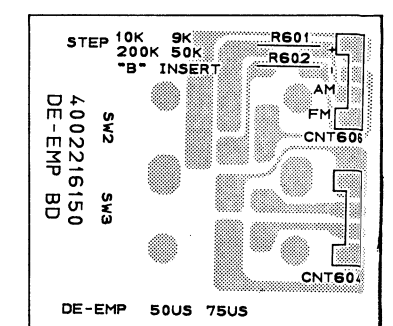

LAMP BOARD 4002216160

(TOP VIEW)

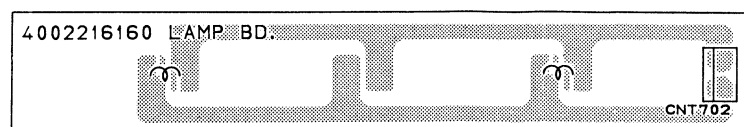

(BOTTOM VIEW)

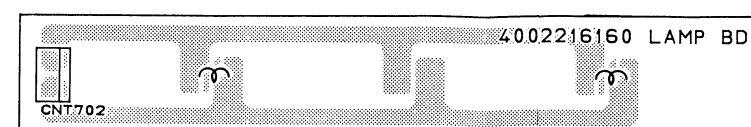

SW BOARD 4002216130

(TOP VIEW)

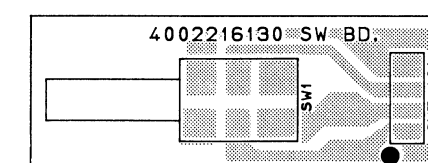

(BOTTOM VIEW)

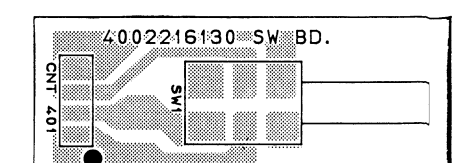

Wiring Diagram

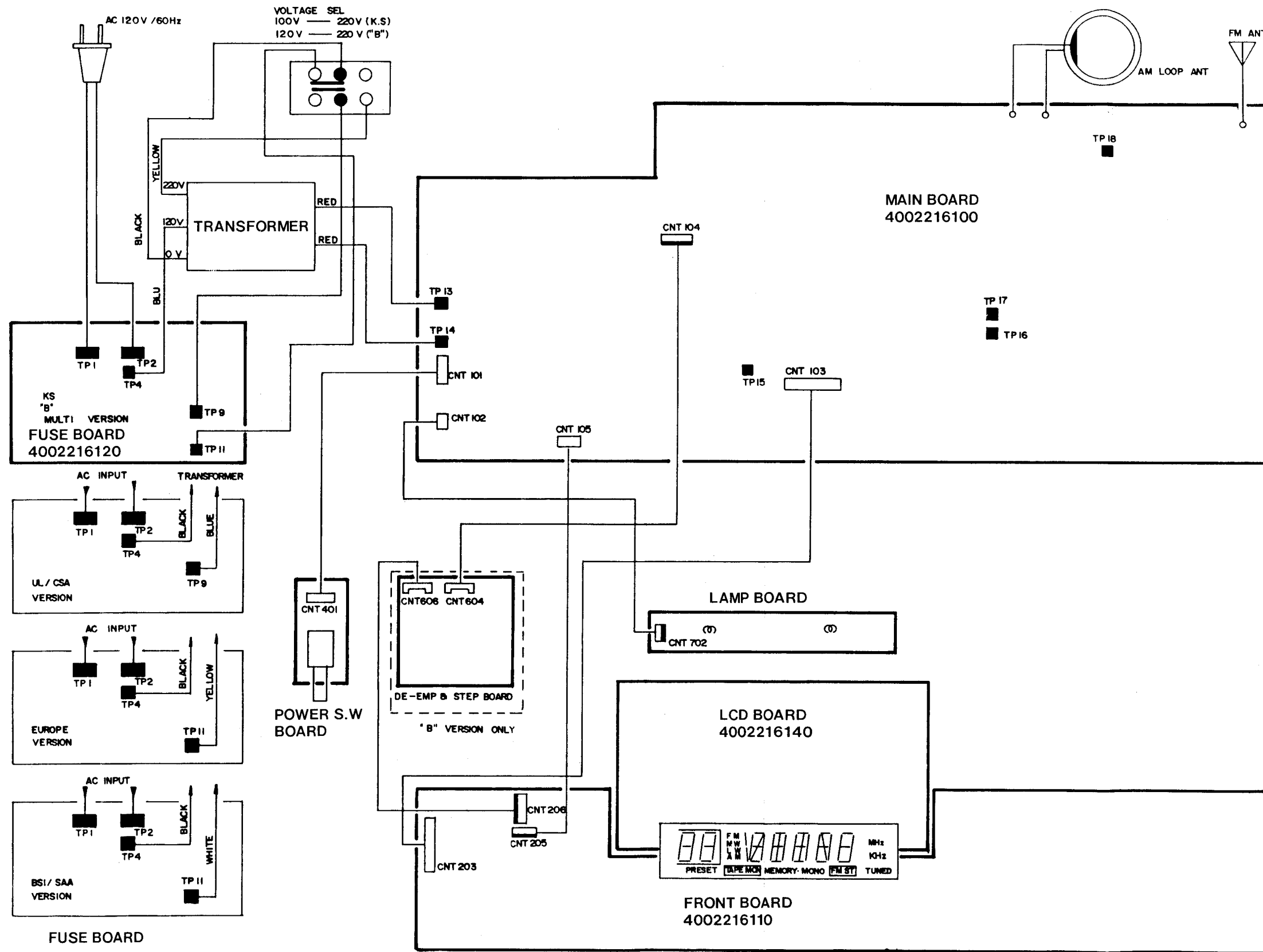

Electrical Parts List

PRODUCT SAFETY NOTICE: Products marked with a Δ have special characteristics important to safety. If you replace any of these components, carefully read the product safety notice of this manual. Don't degraded the safety of the product through improper servicing. Resistors & Capacitors tolerance, D: $\pm 0.5\%$, J: $\pm 5\%$, K: $\pm 10\%$, M: $\pm 20\%$, Z: $+80\%$, -20% .

Ref. No.	Part No.	Description	Position	Remark
Main P.C. Board 4002216100				
Capacitors				
C101	3409210249	Electric SA 1000 μ F 25V M	1A	
C102	3479210141	Electric SA 100 μ F 25V M	1A	
C103	3479210061	Electric SA 10 μ F 35V M	1B	
C104/C105	3679223120	Mylar 0.022 μ F 100V J	1A	
C106	3479247031	Electric SA 47 μ F 16V M	2B	
C107	3479233971	Electric SA 3.3 μ F 50V M	2B	
C108	3479210971	Electric SA 1 μ F 50V M	2B	
C109	3479233971	Electric SA 3.3 μ F 50V M	2B	
C110	3619102110	Poly 1000pF 50V J	2B	
C111	3619681110	Poly 680pF 50V J	2B	
C112	3679473120	Mylar 0.047 μ F 100V J	2B	
C113/C114	3679152120	Mylar 0.0015 μ F 100V J	2B	
(C113/C114)	(3679102120)	Mylar 0.001 μ F 100V J	2B	B,C,D,E,F
C115/C116	3579471130	Ceramic 470pF 50V J	2A	
C117	3579151130	Ceramic 150pF 50V J	2A	B
C118/C119	3479222971	Electric SA 2.2 μ F 50V M	2A	
C120/C121	3679392120	Mylar 0.0039 μ F 100V J	2A	
C122	3409222139	Electric SA 220 μ F 16V M	2B	
C123	3479222971	Electric SA 2.2 μ F 50V M	2B	
C124	3579102530	Ceramic 10000pF 50V Z	2B	
C125	3479210061	Electric SA 10 μ F 35V M	3B	
C126	3579103530	Ceramic 0.01 μ F 50V Z	3B	
C127/C128	3579473530	Ceramic 0.047 μ F 50V Z	3B	
C129	3479247971	Electric SA 4.7 μ F 50V M	3B	
C130	3579331130	Ceramic 330pF 50V J	3B	
C131	3579101130	Ceramic 100pF 50V J	3B	D
C132	3579820130	Ceramic 82pF 50V J	3B	A
C133	3479222971	Electric SA 2.2 μ F 50V M	3B	
(C133)	(3479210971)	Electric SA 1 μ F 50V M	3B	except D
C134	3479247031	Electric SA 47 μ F 16V M	4B	
C135	3579103530	Ceramic 0.01 μ F 50V J	4B	
C136/C137	3579270210	Ceramic CH 27pF 50V K	4B	
C138	3579223530	Ceramic 0.022 μ F 50V J	4B	
C139	3479247031	Electric SA 47 μ F 16V M	4B	
C140	3579103530	Ceramic 0.01 μ F 50V J	4B	
C141	3409210131	Electric SA 100 μ F 16V M	4B	
C142	3679223120	Mylar 0.02 μ F 100V J	3B	
C143	3679563120	Mylar 0.056 μ F 100V J	3B	
C144	3479210061	Electric SA 10 μ F 35V M	3B	
C145	3479247971	Electric SA 4.7 μ F 50V M	3B	
C146/C147	3479210061	Electric SA 10 μ F 35V M	3B/3A	
C148	3579470130	Ceramic 47pF 50V J	3A	
C149	3679473120	Mylar 0.047 μ F 100V J	3A	
C150	3479210061	Electric SA 10 μ F 35V M	3A	
C151	3679332120	Mylar 0.0033 μ F 100V J	3A	
C152	3409210131	Electric SA 100 μ F 16V M	4A	
C153	3579473530	Ceramic 0.047 μ F 50V Z	3A	
C154	3619471110	Poly 470pF 50V J	3A	
C155	3579680130	Ceramic 68pF 50V J	3A	
C156	3579473530	Ceramic 0.047 μ F 50V Z	3A	
C157	3579473530	Ceramic 0.047 μ F 50V Z	3A	D,F
C158	3619181110	Poly 180pF J	3A	D,F
C159		Not used!		
C160	3579220530	Ceramic 22pF 50V J	3A	D,F

Ref. No.	Part No.	Description	Position	Remark
C161	3579103530	Ceramic 0.01 μ F 50V J	3A	D,F
C162		Not used!		
C163	3479210971	Electric SA 1 μ F 50V M	4A	
C164	3479210971	Electric SA 0.1 μ F 50V M	4A	
C165	3479222041	Electric SA 22 μ F 25V M	2A	
C166	3479222041	Electric SA 22 μ F 25V M	2A	
Coils				
L101	2608201120	AM Matching	3A	
L102	2638201150	AM OSC	3A	
L103	2848001250	AM IFT	3A	
L104	2838501110	FM Quad Det A	3B	
L105	2838501210	Quad Det B FM TOK	3B	
L106	2648601430	Inductor 20.8mH	3B	D
LL101	2608201130	LW Matching	3A	D,F
LL102	2638401060	LW OSC	3A	D,F
Ceramic Filters				
CF101/102	3908011001	10.7 MA8K-A	4A/3B	A, Domestic
(CF101/102)	(3908011011)	10.7 MS3GH	4A/3B	B,C,D,E,F
CF103		Not used!		
CF104	3908001120	BFU450CN	3A	
CF105	3908001150	SFZ 450B	3A	
F107/F108	2658301100	MPX Filter 19kHz	2A	
Connectors				
CNT101	4428517710	Plug 4P	1B	
CNT102	4428517510	Plug 2P	1B	
CNT103	4428518110	Plug 8P	2B	
CNT104	4358504160	Ass'y 4P to De-emphasis Board	2A	B
CNT105	4428517610	Plug 3P	1B	
CNT106	4428511110	Plug 2P	2B	
	4428511220	Remocon Ass'y 2P	2B	
Diodes				
D101-D104	2258106100	1N4002	1A	
D105 Δ		Not used!		
D106 Δ	2058599109	Zener DZ 15BH	1B	
D107	2058599103	Zener DZ 5.1BM	2B	
D108-D113	2058306101	1N4148	2B/2A	
D114/D115	2058306101	1N4148	2B/3B	
D116	2058306101	1N4148	3B	
D117/D118	2058306101	1N4148	4B	D,F
D119/D120	2058306101	1N4148	3A	D,F
VD101/102	2058819106	Varactor KV1236Z	3A	
(VD101/102)	(2058819105)	Varactor KV1235Z	3A	D,F
VD103	2058819105	Varactor KV1235Z	3A	D,F
ICs				
IC101	2168411105	HA 12016, MPX IC	2B	
IC102	2168017128	LA 1266, IF	3B	

Ref. No.	Part No.	Description	Position	Remark
IC103	2138017112	LM 7001, PLL	4B	
Trimmers				
TC101	3838001160	Trimmers 20pF	3A	
TC102	3838001150	Trimmers 10pF	3A	
LTC101	3838001160	Trimmers 20pF	3A	D,F
LTC102	3838001160	Trimmers 20pF	3A	D,F
Resistors: All resistors are 1/5W $\pm 5\%$ tolerance, unless otherwise specified. M is metal film, M.O is metal oxide and C is cement type.				
R101 Δ	3039100572	M.O, 10 Ω 2W	1B	
R102 Δ	3039339472	M., 3.3 Ω 1W	1B	
R103 Δ	3009561273	M., 560 Ω 1/4W	1A	
R104	3069102970	1k Ω	1B	
R105	3069223970	22k Ω	1B	
R106 Δ	3039151472	M., 150 Ω 1W	2B	
R107	3069103970	10k Ω	2B	
R108/R109	3069332970	3.3k Ω	2A	
R110/R111	3069332970	3.3k Ω	2A	
R112/R113	3069332970	3.3k Ω	2A	A,B, Domestic
(R112/R113)	(3069122970)	1.2k Ω	2A	C,D,E,F
R114	3069392970	3.9k Ω	2A	
R115	3069473970	47k Ω	2A	
R116	3069332970	3.3k Ω	2A	
R117	3069223970	22k Ω	2A	
R118	3069332970	3.3k Ω	2A	
R119	3069223970	22k Ω	2B	
R120	3069473970	47k Ω	2B	
R121	3069104970	100k Ω	2B	
R122	3069102970	1k Ω	2B	
R123	3069562970	5.6k Ω	2B	
R124	3069562970	5.6k Ω	2B	
R125 Δ	3009220270	M., 22 Ω 1/4W	2B	
R126/R127	3069562970	5.6k Ω	2A	
R128	3069472970	4.7k Ω	2A	
R129	3069103970	10k Ω	2A	
R130	3069473970	47k Ω	2A	
R131	3069332970	3.3k Ω	2A	
R132	3069103970	10k Ω	2A	
R133	3069473970	47k Ω	2A	
R134 Δ	3009471273	M., 470 Ω 1/4W	3A	
R135	3069103970	10k Ω	2B	
R136	3069473970	47k Ω	2B	
R137	3069103970	10k Ω	2B	
R138 Δ	3009220273	22 Ω	3B	
R139	3069332970	3.3k Ω	3B	
R140	3069103970	10k Ω	3B	
R141	3069104970	100k Ω	3B	
R142	3069473970	47k Ω	4B	
R143	3069473970	47k Ω	4B	
R144	3069473970	47k Ω	4B	
R145	3069472970	4.7k Ω	4B	
R146	3069472970	4.7k Ω	4B	
R147	3069472970	4.7k Ω	4B	
R148/R149	3069101970	100 Ω	4B	
R150	3069101970	100 Ω	4B	
R151 Δ	3009560273	M., 56 Ω 1/4W	4B	
R152	3069821970	820 Ω	4B	
R153	3069152970	1.5k Ω	4B	
R154	3069101970	100 Ω	4B	

Ref. No.	Part No.	Description	Position	Remark
R155	3069101970	100 Ω	4B	
R156	3069103970	10k Ω	4B	
R157 Δ	3009101273	M., 100 Ω 1/4W	3B	
R158	3069104970	100k Ω	4A	
R159	3069473970	47k Ω	4A	
R160 Δ	3009101273	M., 100 Ω 1/4W	4A	
R161	3069181970	180 Ω	4A	
R162	3069561970	560 Ω	4B	
R163	3069471970	470 Ω	3B	
R164	3069332970	3.3k Ω	3B	
R165	3069331970	330 Ω	3B	
R166	3069101970	100 Ω	3B	
R167	3069272970	2.7k Ω	3A	A,B, Domestic
(R167)	3069182970	1.8k Ω	3A	C,D,E,F
R168	3069820970	82 Ω	3B	
R169	3069272970	2.7k Ω	3B	A,B, Domestic
(R169)	(3069332970)	3.3k Ω	3B	C,D,E,F
R170	3069243970	24k Ω	3B	
R171	3069103970	10k Ω	3B	
R172	3069223970	22k Ω	3A	
R173	3069183970	18k Ω	3B	A, Domestic
(R173)	(3069333970)	33k Ω	3B	B,C,D,E,F
R174/R175	3069104970	100k Ω	3A	
R176	3069104970	100k Ω	3A	D,F
R177	3069155970	1.5M Ω	3A	D,F
R178/R179	3069473970	47k Ω	3A	D,F
R180	3069104970	100k Ω	3A	D,F
R181	3069473970	47k Ω	3A	D,F
R182	3069103970	10k Ω	3A	D,F
R183-R198		Not used!		
R199	3069153970	15k Ω	3B	C,D,E,F
VR1				

Ref. No.	Part No.	Description	Position	Remark
X-FMR. △	2828057007	Power Transformer, 240V 50Hz		E
X-FMR. △	2828056807	Power Transformer, 100/220V 60Hz		Domestic
Front Board 4002216110				
Capacitors				
C201	3479210871	Electric SA 0.1μF 50V M		
C202		Not used!		
C203/C204	3529330210	Ceramic CH 33pF 50V K		
C205	3439147312	Electric SA 0.047μF 5.5V M		
X-TAL	3939101830	Resonator 4MHz		
L201/L202	2648601010	Inductor 2.2μH		
CNT203	4358508216	Ass'y 8P to Main Board		
CNT205	4358503160	Ass'y 3P to Main Board		
CNT206	4358504351	Ass'y 4P to Main Board		
Diodes				
D201 △	2058599123	DZ 8.2BL, Zener		
D202-D208	2058306101	1N4148		
IC201	2138309131	IC, MC68HC05C4 DWP-501A		
Q201-Q203	2208606104	TR, NPN KTC1815Y		
Switch Board 4002216130				
CNT401	4358504180	Ass'y 4P to Main Board		
De-Emphasis Board 4002216150 ('B' version only)				
Connectors				
CNT604	4428519410	Plug 4P		
CNT606	4428519410	Plug 4P		
Resistors				
R601/R602	3069103970	10kΩ		
Fuse Board 4002216120				
Fuses △				
F101	5508110931	SB, 0.15A/250V AC		A, Domestic
F102	5508300534	T 63mA/250V AC		C, D, E, F
(F101)	(5508211230)	NB 0.25A/250V AC		B
(F102)	(5508210930)	NB 0.15A/250V AC		
Resistors				
R501 △	3009335373	M, 3.3MΩ 1/2W		
Lamp Board 4002216160				
Connector				
CNT702	4358502140	Ass'y 2P to Main Board		

Ref. No.	Part No.	Description	Position	Remark
LCD Board 4002216140				
Capacitors				
C301	3479210121	Electric 100μF 10V M		
C302	3579681230	Ceramic 680pF 50V K		
C303	3479247031	Electric 47μF 16V M		
Diodes				
D301	2058599123	Zener DZ8.2B		
LCD	2338170350	LCD 8118JNP1		
IC				
IC301	2168017131	IC, LC7582 LCD Driver		
Resistors				
R301	3069122970	1.2kΩ		
R302	3069101970	100Ω		
R303	3069473970	47kΩ		
R304/R305	3069103970	10kΩ		
R306	3069472970	4.7kΩ		
R307	3069473970	47kΩ		
Transistors				
Q301/Q302	2208606104	NPN KTC1815Y		

Mechanical Parts List

No.	Part No.	Description	Qty	Position	Remark
1	046122015911	Cover Top, Black	1	C3	
2	6123405410	Cover Bottom	1	E4	
3	046035101511	Foot with Rubber, Gold Front	2	D5	Domestic, A
	046035101511	Foot with Rubber, Gold	4	D5	B, C, D, E, F
4	6035101510	Foot with Rubber, Black Rear	2	E5	Domestic, A
		Not used!	0	.	B, C, D, E, F
5	6121602210	Chassis Main	1	E4	
6	048501014911	Panel Front, Black	1	C6	
7	048545048211	Button Power	1	A5	
7-1	8545048210	Button Power	1	A5	Domestic
8	6555004380	Spring Push, Power	1	A5	
9	048543014016	Knob Tact A-1	1	B4	
10	048543014017	Knob Tact A-2	1	B4	
11	048543014111	Knob Tact, Up/Down	1	C6	
12	8543023510	Knob Tact, FM/AM	1	C6	
13	8545048710	Knob Tact, C	1	B6	
14	6555004350	Spring Push, Power	3	B6	
15	04853008312	Window Display	3	B6	
16	048535027311	Name Badge, Sherwood	1	C6	
16-1	048535019021	Name Badge	1	C6	Domestic
17	6513003410	Holder LCD	1	B4	
18	6513003610	Holder Lamp	1	C4	
19	046102027021	Chassis Back, Black	1	F4	A
	046102027031	Chassis Back, Black	1	F4	B
	046102027041	Chassis Back, Black	1	F4	C
	046102027051	Chassis Back, Black	1	F4	D
	046102027061	Chassis Back, Black	1	F4	E
	046102027071	Chassis Back, Black	1	F4	F
	046102027011	Chassis Back, Black	1	F4	Domestic
20	4308003910	Cord AC Power, Black	1	E1	A, B
	4308000430	Cord AC Power, Black	1	E1	C, D, F
	4308003610	Cord AC Power, Black	1	E1	E
	6518000810	Cord AC Power, Black	1	E1	Domestic
21	6518000111	Stopper Cord, Black	1	D1	
	6513000310	Stopper Cord, Black	1	D1	Domestic
22	6518001310	Holder Antenna.	1	F2	
23	4408102610	Terminal Ant., 4P	1	E3	Except D
24	7505206220	Heat sink Regulator TR	1	D3	
25	4438101510	RCA Jack, 2P	1	D3	
26	6705004220	Spacer W/PCB	4	D4	
27	6528300210	Fastner W/PCB	2	D3	
28	8535027710	Diffuser LCD	1	B4	
29	2528203810	Lamp, 12V 100mA	2	C4	
30	4628055410	Switch Push	1	B4	
31	4658002020	Switch Tact	17	D5	
32	4355023110	Connector Ass'y 2P, Remocon	1	F2	
33	4408001310	Terminal Ant., 2P	1	E3	D
34	4438301110	Jack DIN	1	F4	D
35	4618001610	Slide Switch	2	E3	B
36	4618000410	Voltage Selector	1	D2	Domestic, B
37	6515000630	Holder Voltage	1	D1	Domestic, B
38	4408104910	Terminal Ground	1	F3	Domestic
• Screws					
S1	8159440083	WSAM 4×8 ZNB	4		
S2	8119230083	#2 BTC 3×8 ZNB	9		
S3	8119226081	#2 PTC 2.6×6 ZNY	9		
S4	8159230081	#2 WPTC 3×8 ZNY	8		
S5	8159440081	WSAM 4×8 ZNY	2		
S6	8159230141	#2 WPTC 3×14 ZNY	4		
S7	8119240061	#2 PTC 4×6 ZNY	1		Domestic
S8	8109230081	#2 BTC 3×8 ZNY	23		

A

B

C

D

Schematic Diagram TD2220C(II)

1

2

3

4

5

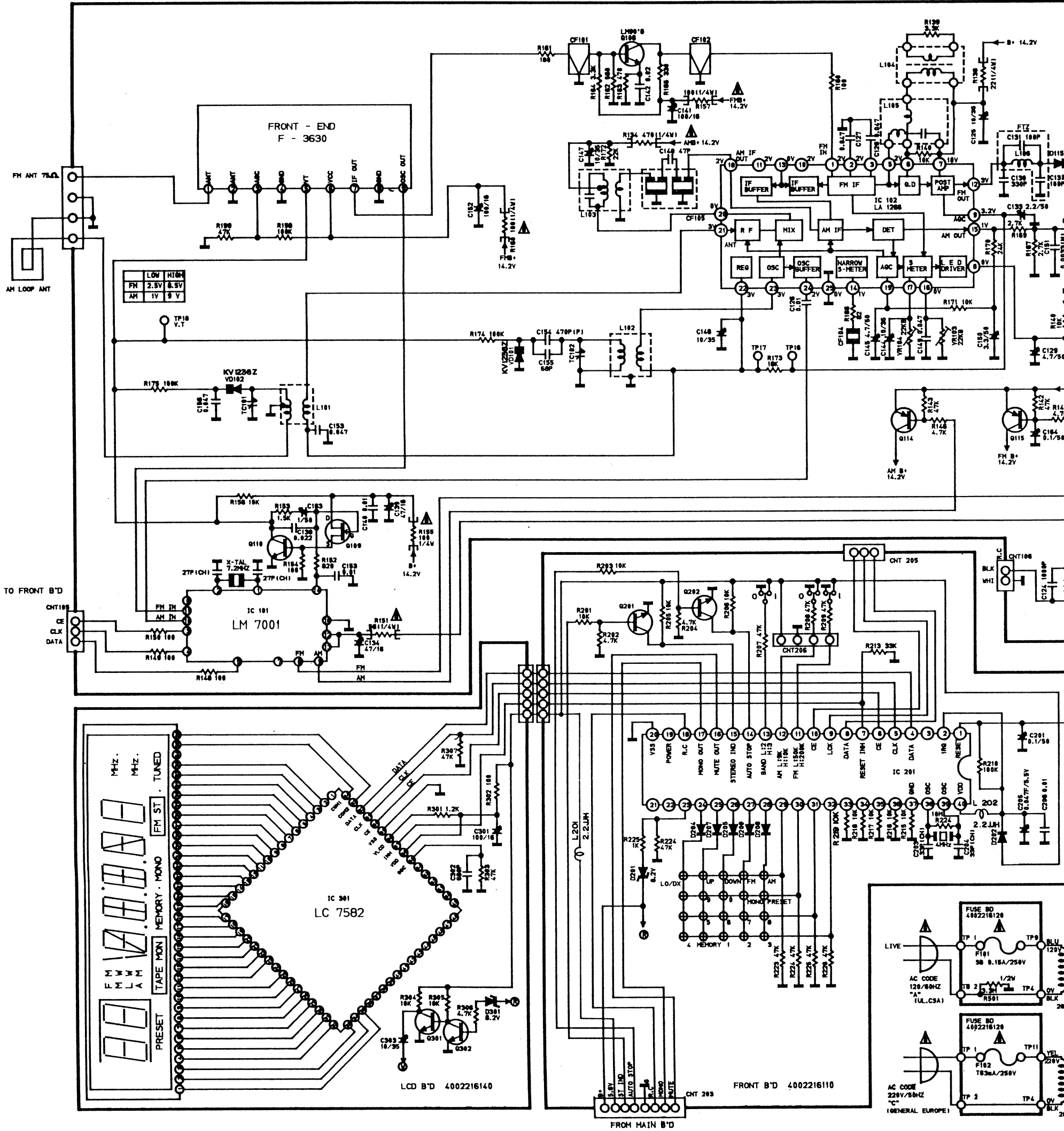

A

B

C

D

Schematic Diagram

TD2220C

1

2

3

4

5

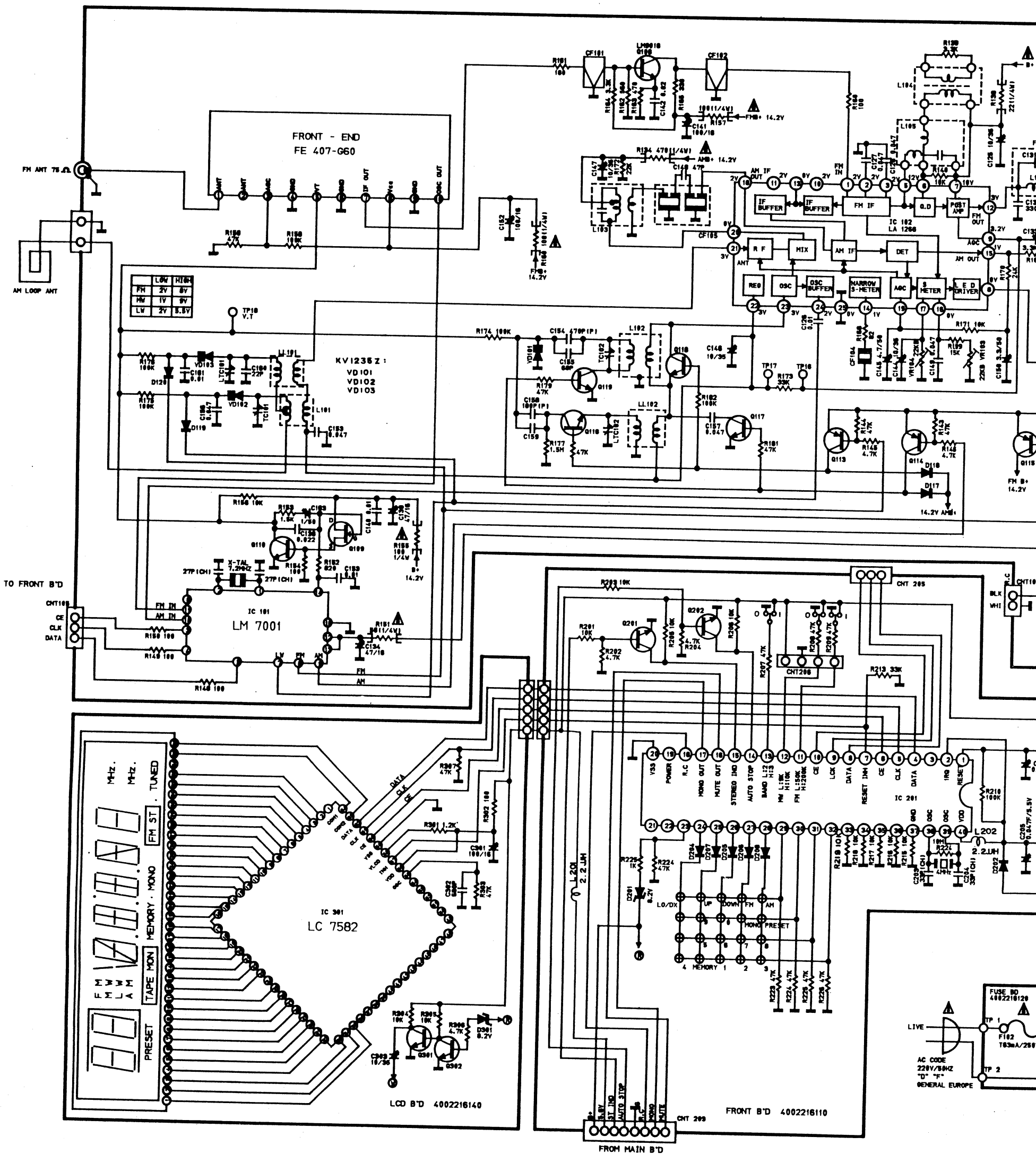

D

E

F

G

Schematic Diagram

TD2220C(I)

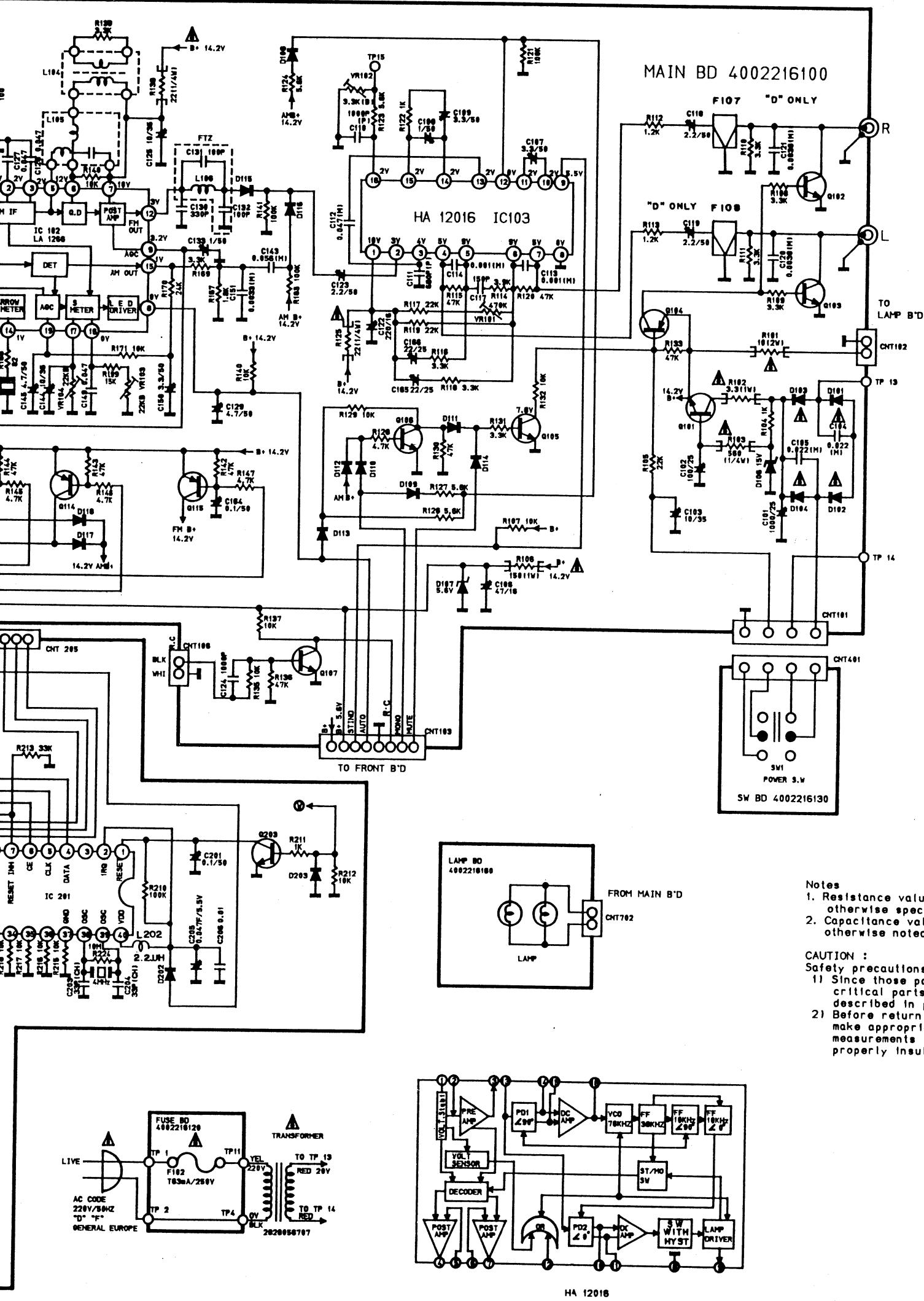

FRONT END : "D" /FE 407-060
 "F" /F-3630

FTZ

IC101 : LM 7001
 IC102 : LA 1266
 IC103 : HA 12016
 IC201 : MC 68HC05C4 DWP-501A
 IC301 : LC 7582

DZ 6.2V : D201, D301
 SW : POWER SW
 1N4148 : D108, D109, D110, D111, D112, D113, D114, D115, D116, D117, D118
 1N4002 : D101, D102, D103, D104
 DZ 5.68M : D107
 WZ15 : D106
 DZ 6.2V : D210, D301
 FET 2SK 1680 : Q109
 TR KTC 1815Y : Q105, Q106, Q210, Q202, Q203, Q301, Q302, Q116, Q117, Q118, Q119
 KTD 1302 : Q102, Q103
 KTA 1015Y : Q104, Q113, Q114, Q115
 LM 9018Y : Q108
 KTD 1406 : Q101
 KTD 2240BL : Q110
 MW MATCHING COIL : L101
 LW MATCHING COIL : LL101
 MW OSC COIL : L102
 LW OSC COIL : LL102
 FM MUTE LEVEL ADJ : VR103
 MW MUTE LEVEL ADJ : VR104
 VCO ADJ:VR102
 SEPERATION ADJ : VR101
 DET A:L105 DET B:L104

⊠ "D", "F"
 R207 → 1, R208 → 0, R209 → 0
 * "D"
 F107, F108 : FILTER 18 KHZ. (FTZ)

Notes
 1. Resistance values are indicated in ohms unless otherwise specified (K-1,000, M-1,000,000)
 2. Capacitance values are shown in microfarads unless otherwise noted (P-micro-micro farads).

CAUTION :
 Safety precautions to be followed during servicing
 1) Since those parts marked with ⚠ are critical parts for safety, use the one described in parts list
 2) Before returning the appliance to the customer, make appropriate leakage current or resistance measurements to determine that exposed parts are properly insulated from the supply circuit.

(3 BAND)